

## Wood characteristics

Wood has a number of specific characteristics, which are natural and inherent to it. The biggest practical moment is, that the wood has its specific colour and density, also the effect of humidity result.

In longitudinal cut most of the wood has a nice, decorative and often very appreciable cut-out which is called texture.

Wood has a specific scent. The scent is given by attars, resins and fermented substances. New-mown wood gives a better scent.

A very important attribute of the wood is to store and easily return the water.

**The bad** attribute is to bloat and dry out. When wood is drying, it shrinks its linear measurements and volume decrease. When the wood absorbs humidity its linear measurements and volumes increase.

**Downsides** of the wood are that it chaps and warps. When wood dries, humidity firstly evaporates from the surface, outer layers and only after from deeper inside layers. That is why, when the outer layers start to shrink, the inside layers, due to bigger wetness, oppose to drawing. Firstly the surface is chapping, next the inside. When wood dries it can have longitudinal or cross warp. Longitudinal: When dried straight balk bends, flat plank twists and gets the form of the propeller. Cross: When the form of woods' cross-section is changing, quadratic balk becomes the balk with rectangular or rhomb cross-section, flat plank becomes hunched.

Wood has a number of specific technological characteristics. It easily splits along the fibre, nicely holding metal fastenings, it can flex easily, is durable to depreciation. Screws hold in the wood extremely well. Screws have a much better grip with the wood than the nails, and they do not cut the strings.

**Peculiarity of the wood (taints):** branchy wood, cracks, subnormal structure, infractions made by fungus and insects. Wood, as it is a product of biological origin, is so varied, that the concepts "normal wood" or "subnormal wood" often has a conditional complexion. On sawn-on wood and sawn timber assortment following fungus taints may occur: mould, brownness. Mould funguses generally do not affect physical and mechanical characteristics of the wood.

When wood is affected by biological (fungus), physical (environmental temperature and humidity) and chemical factors – it decomposes.

Wood may last a long time, but volatile humidity and temperature of the environment reduces its lasting, because of that, a variety of cracks, which can damage the woods' integrity ,upspring, that facilitates woods' infection with fungus, and its rapid development. The older the wood is, the better its timbers durability is.

The most effective way to protect the wood from insect and decay is to soak it with special preparations, which are toxic to fungus and insects, - antiseptics.

## Garden house Liverpool 4x3 (44 mm) specification

*Liverpool 4 x 3, 44 mm*

<b>Position</b>	<b>Name</b>	<b>B width mm</b>	<b>H Height mm</b>	<b>L Length mm</b>	<b>Q.</b>
003.	Impregnated logs	45	50	3813	7
008.	Ground floor tongue and grooved planed boards				10,5 m2
008a.	Ground floor tongue and grooved planed boards				
009.	Floor strips	25	30	3767 /2767	2+2
017.	various walls logs	44	135		
037.	Roof boards				18 m2
037a	Roof boards				
039.	Fascia board	20	110	2217	4
039a	Fascia board strip	20	110	2227	4
039b	Roof strip	20	110	4000	2
044.	Outside doors	A 1295x1860 mm (double glazed)			1
045.	Windows	C 1380X910 mm (double glazed)			2
046.	Window strips	18	65	1470	8
046a	Window strips	18	65	870	8
046b	Door strips	18	65	1385	4
046c	Door strips	18	65	1820	4
058.	Rhomb	20	110	200	2
070.	Windows, doors furniture				3

## Assembly guide Liverpool 4x3

Assembling this Log Cabin “Liverpool 4x3” should take place during dry weather only. If it starts to rain during the assembling process, the wood should be covered over.

After completion, the cabin should be immediately protected with an appropriate paint or wood treatment.

Before erecting this cabin it is important to make a firm base, ideally using concrete or concrete slabs.

It is very important that the base corners must be at right angles it is completely level.



After completing the base the bearers, Pos. 003 are put into position following the Installation Guide diagrams, and then bolted into position.

**The space between impregnated floor joists must be kept exactly how is shown at the Foundation plans (according to the picture at page 4)**

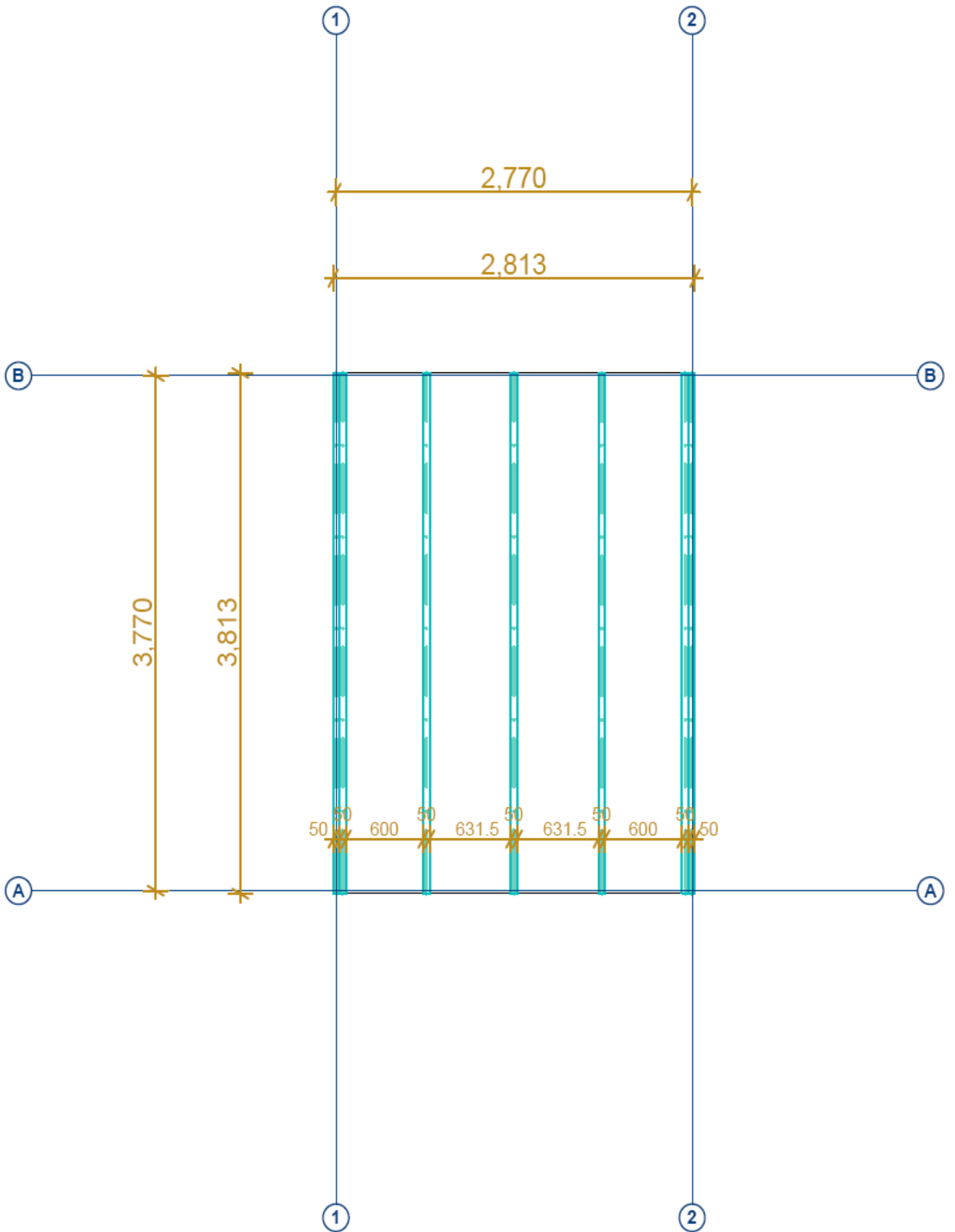

It is advisable to use a spirit level during the construction of the cabin. Using the Installation guide together with the Parts List for reference you can start erecting the walls. Beginning with part No. 1-1-BA and 1-2-BA for the back and front walls and following the installation Guide, fit the boards' one on top of the other. Ensuring the corners lock. Again it is advisable to use a spirit level during this process.

When the external walls reach the height of the gables the doors can be installed.

Now you can position the pre-fabricated gable, part No. from 16-1-BA to 20-1-Y2, from 16-2-BA to 20-2-Y2.

When the gable is in position the roof joists can be put in to place. This is followed by the roof boards' pos. 037 which are screwed or nailed into place. This process should be done working from the front to the back.

As soon as the roof is installed it should be sealed immediately with roofing felt and/or Bitumen tiles – which are supplied as optional extras.

When the tiles/felt is in place the border for the gables and eaves Pos. 039, 039a and 039b can be screwed or nailed into place.

Floorboards pos. 008 is fitted last. These are screwed or nailed onto the bearers' pos. 003.

The roofing and flooring is commercial quality tongue and groove. The smooth planed side of the flooring boards should be placed upper- most.

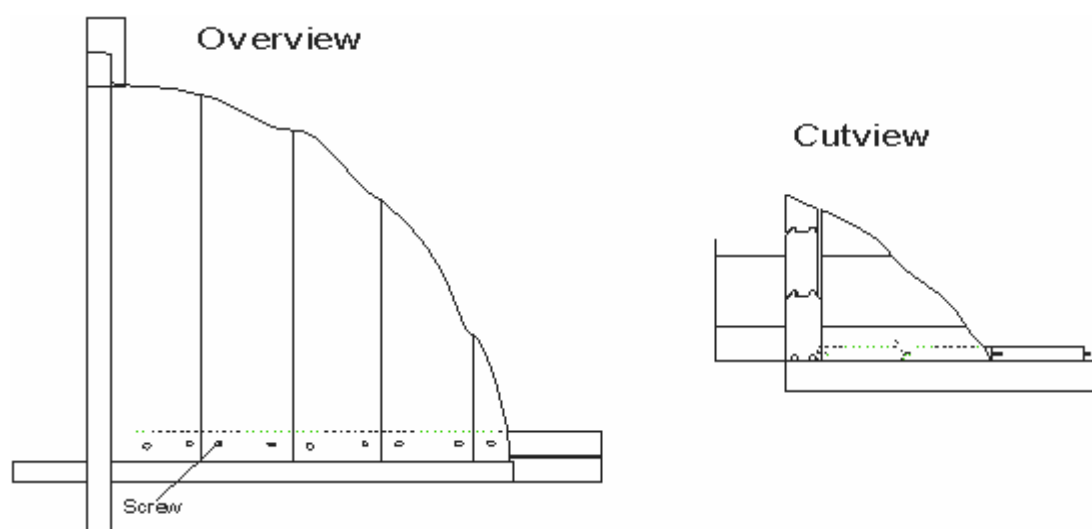

**ATTENTION: Before you start the mounting the floor boards, please pay attention to the specification on the page 2.**

If pos. 08 at the specification is from two positions (floor boards are butt – jointed) - pos. 08 and pos. 08a, you must put the impregnated floor joist exactly how is shown at the foundation plan.

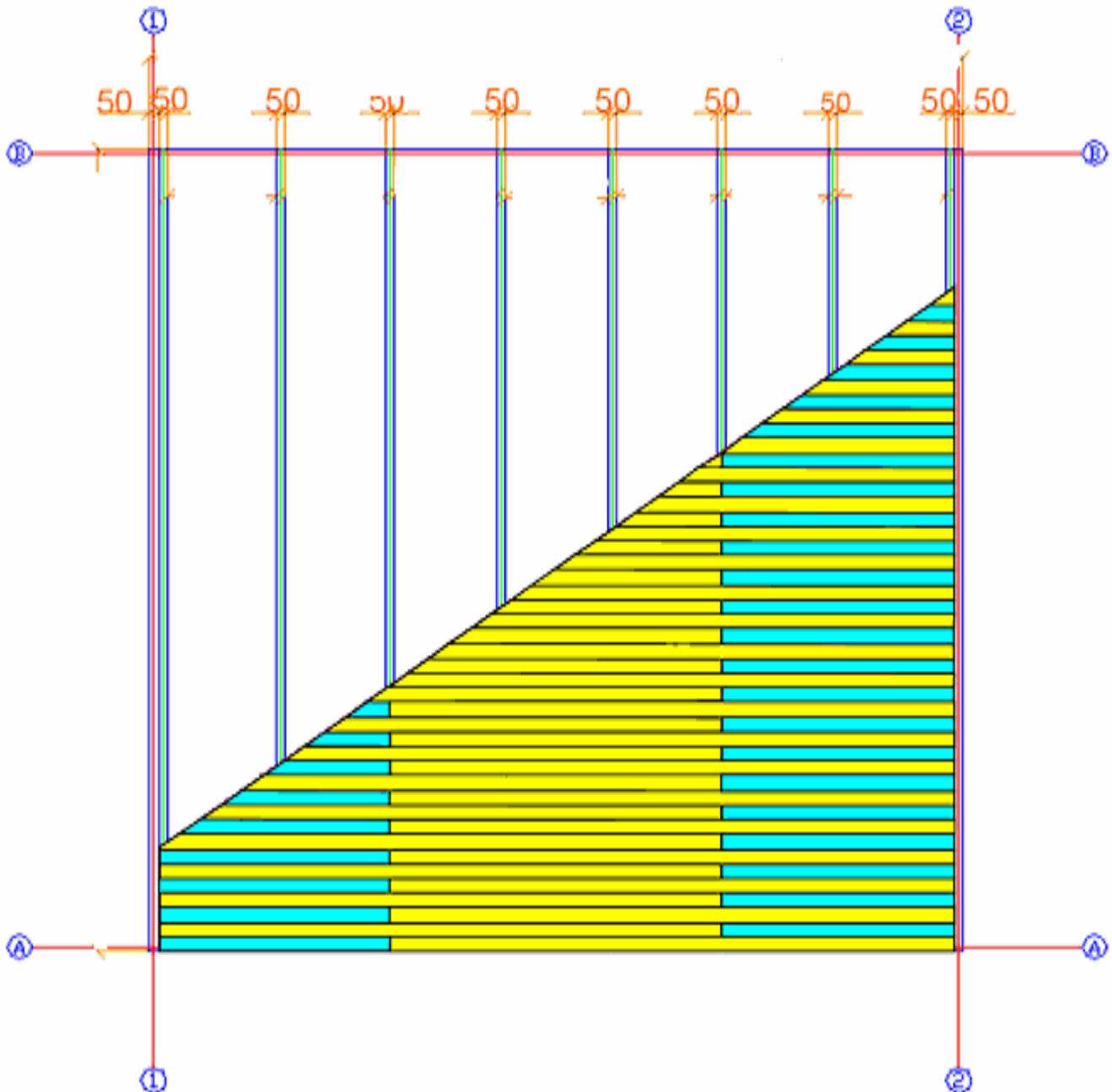

All parts of the log cabin are numbered.

**ATTENTION:** These numbers correspond to numbers in the parts list you will receive in your log cabin booklet. Before construction please check the received parts against the parts list as it is more difficult to resolve issues during the construction stage.

# Wall on axis 1

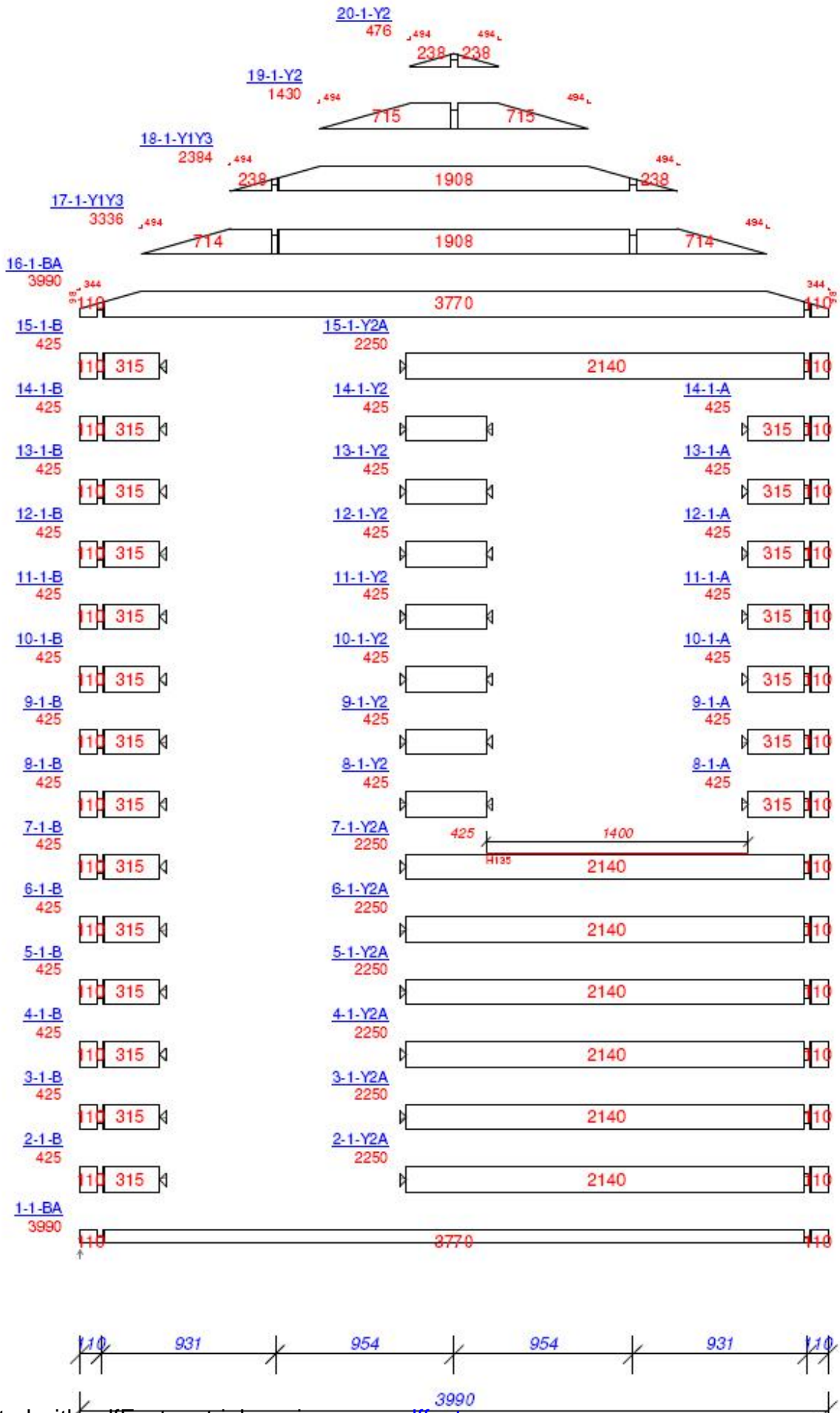

## Wall on axis 2

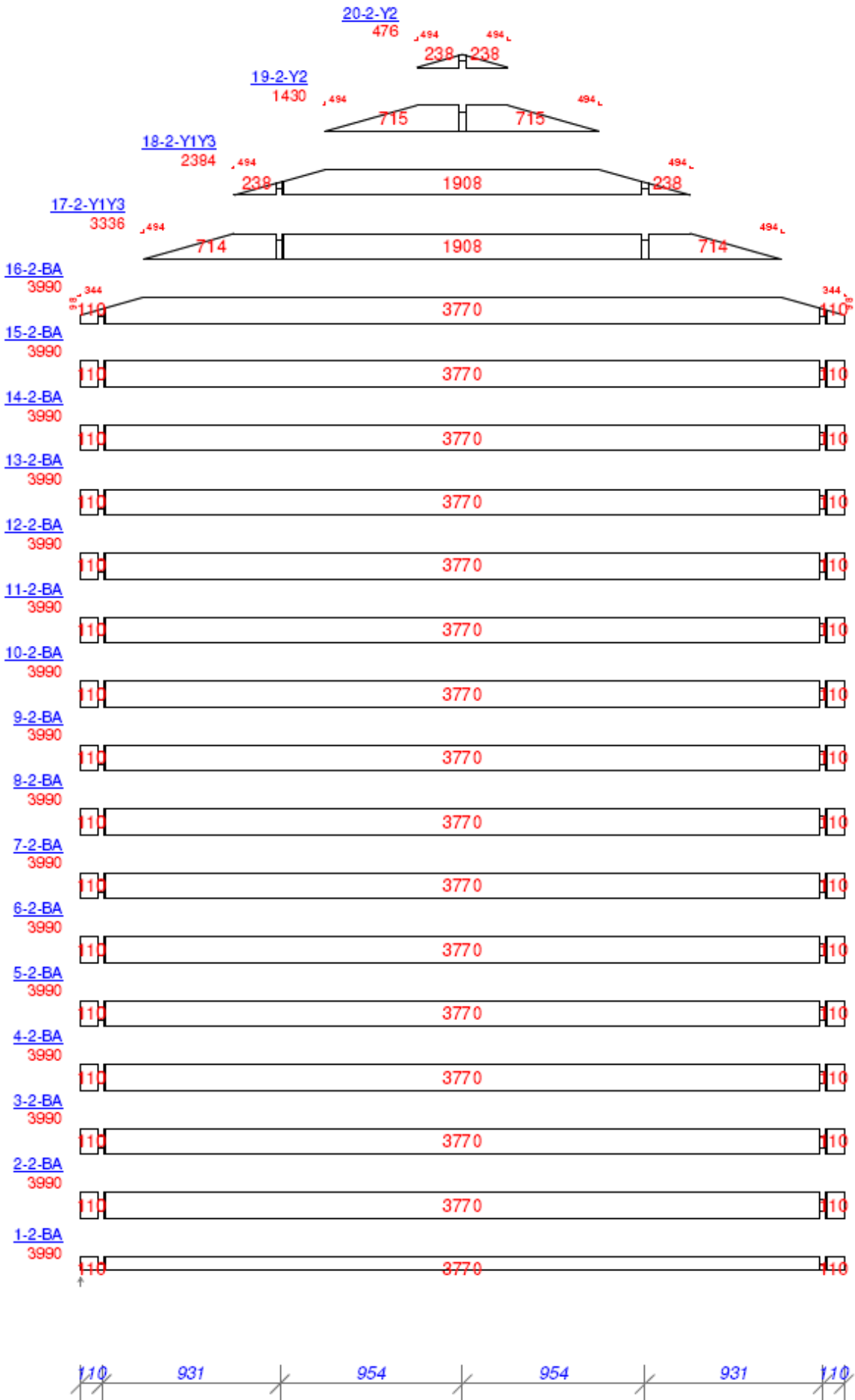



## Wall on axis A

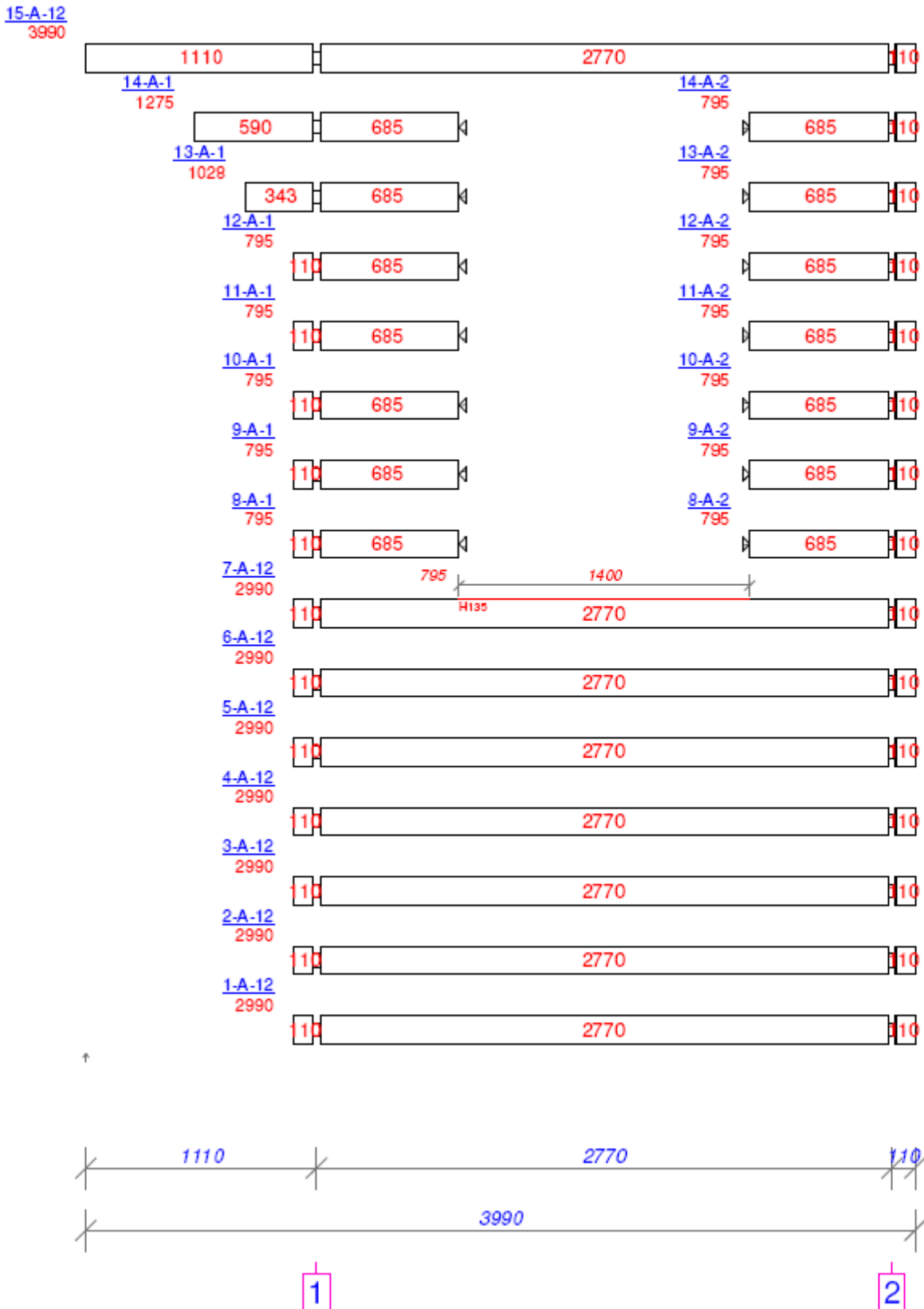

## Wall on axis B

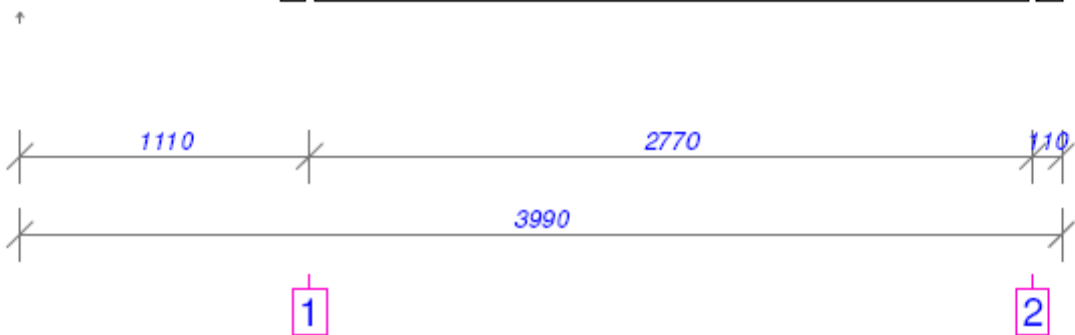
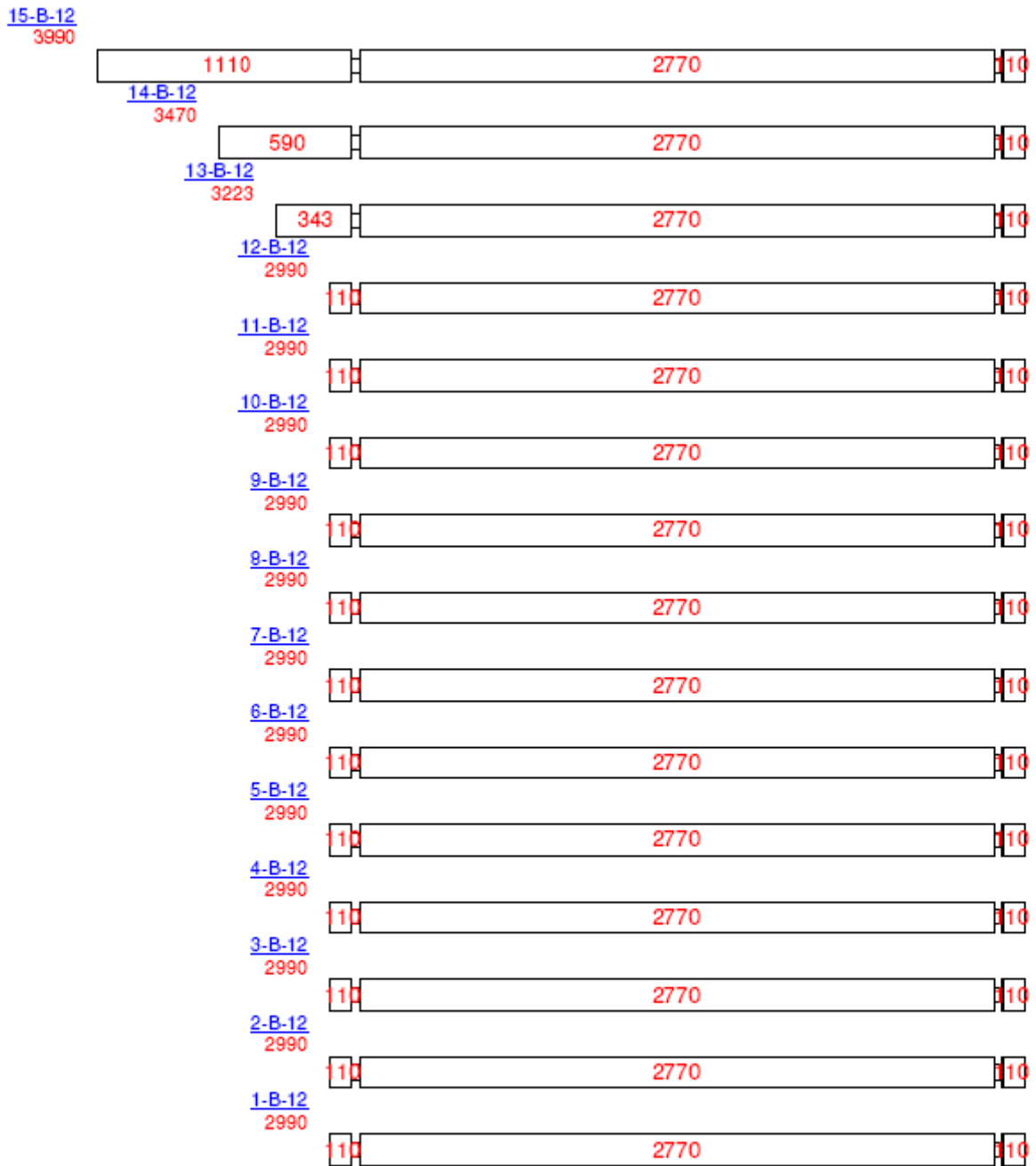

### Wall on axis Y1

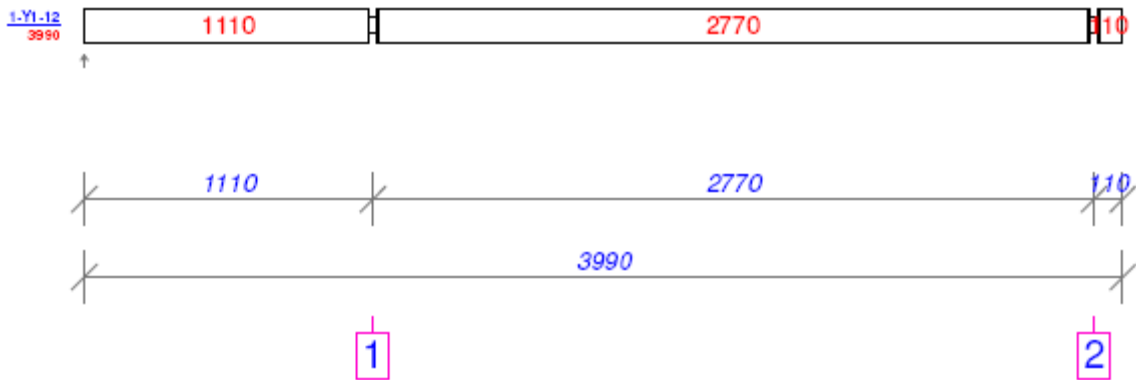

### Wall on axis Y2

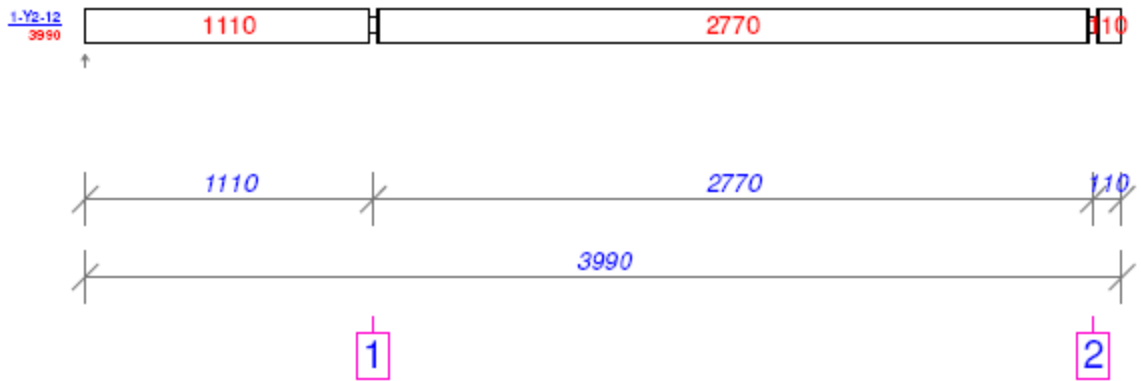

### Wall on axis Y3

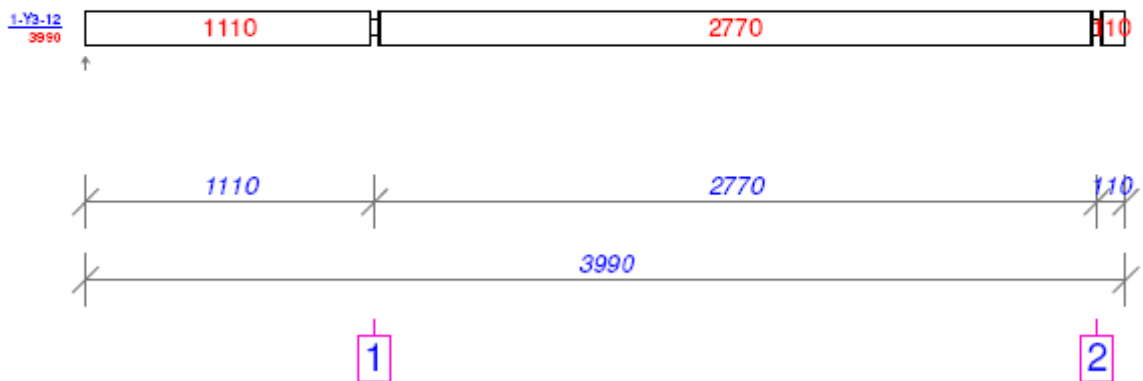

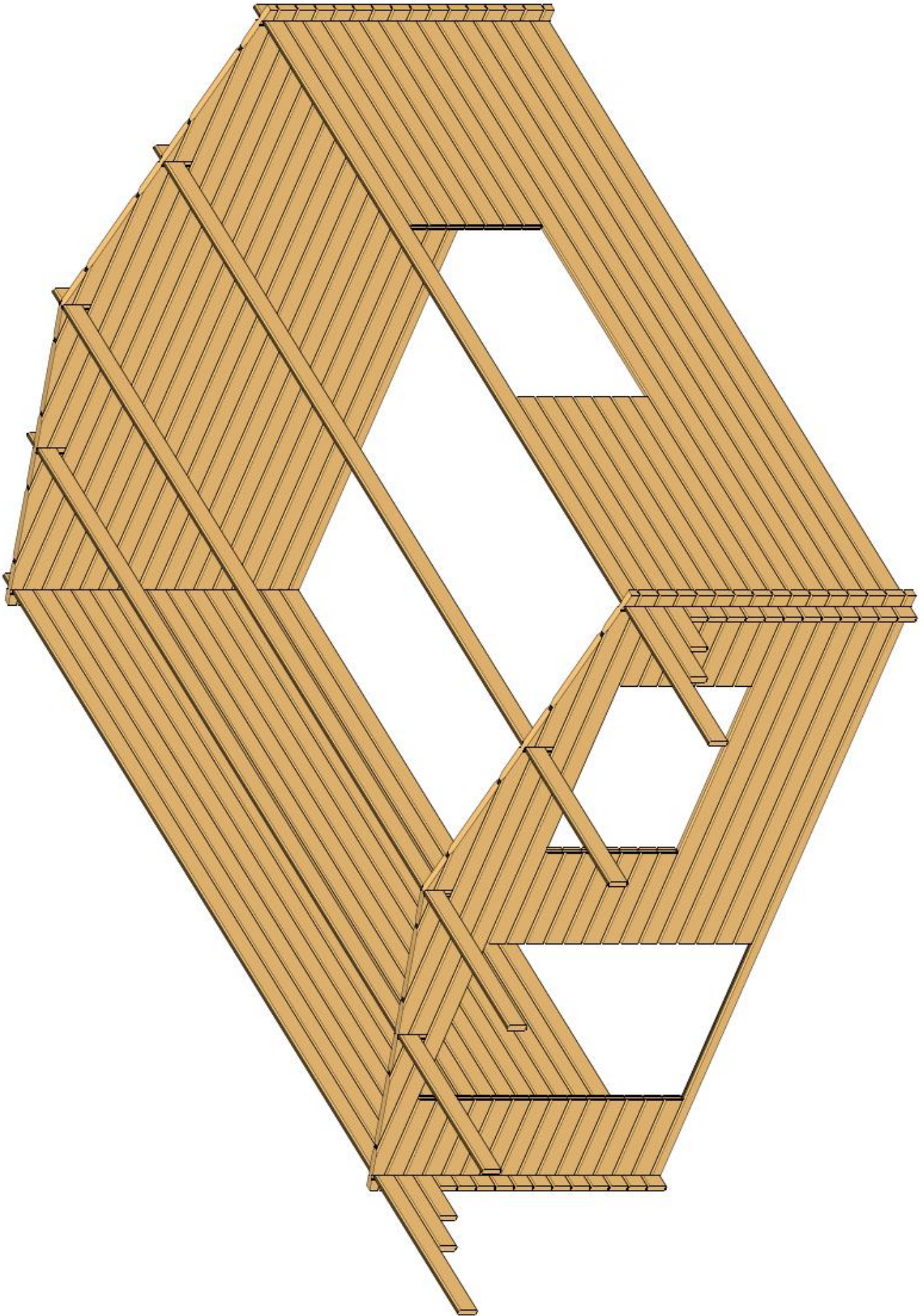

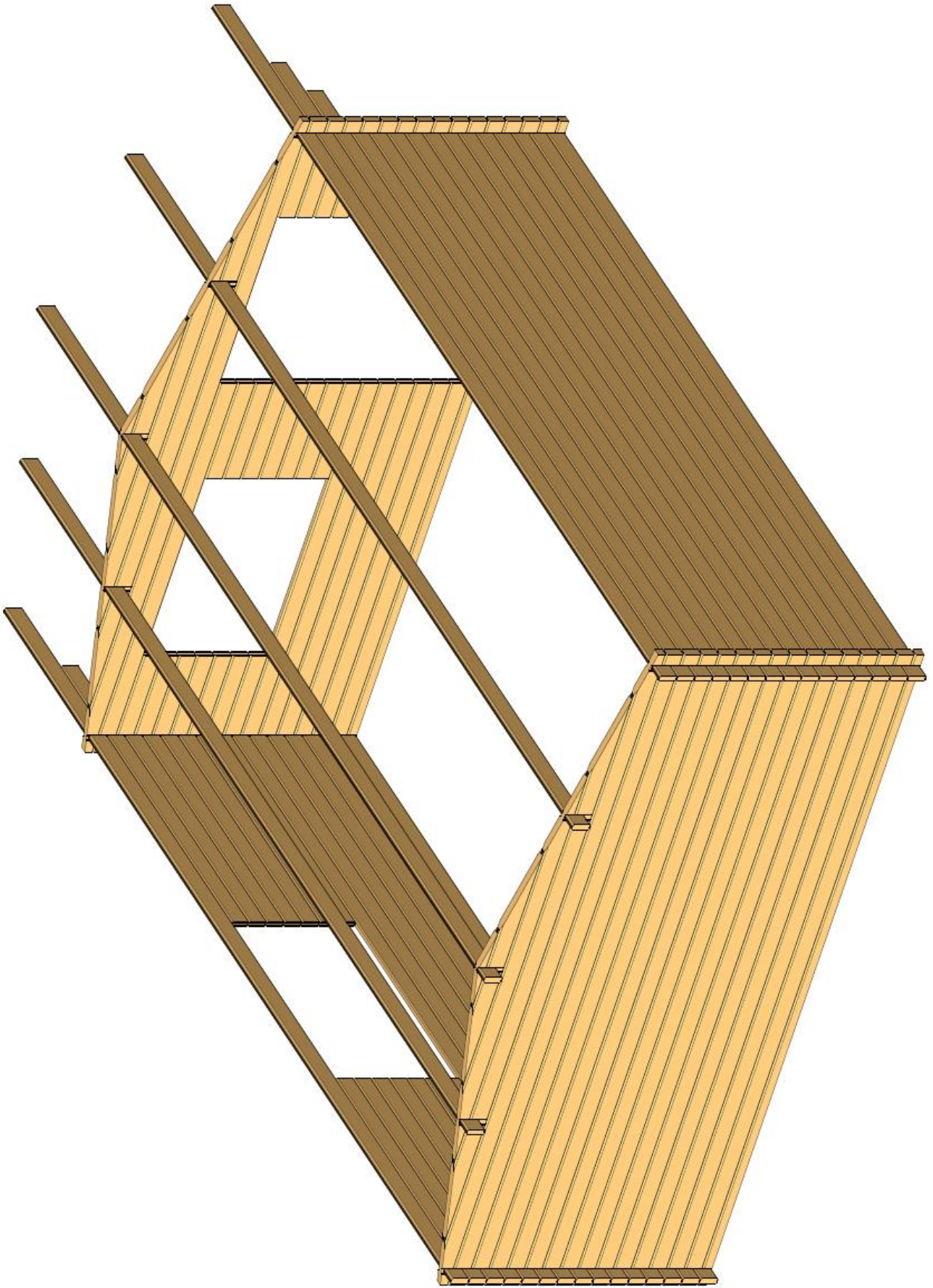

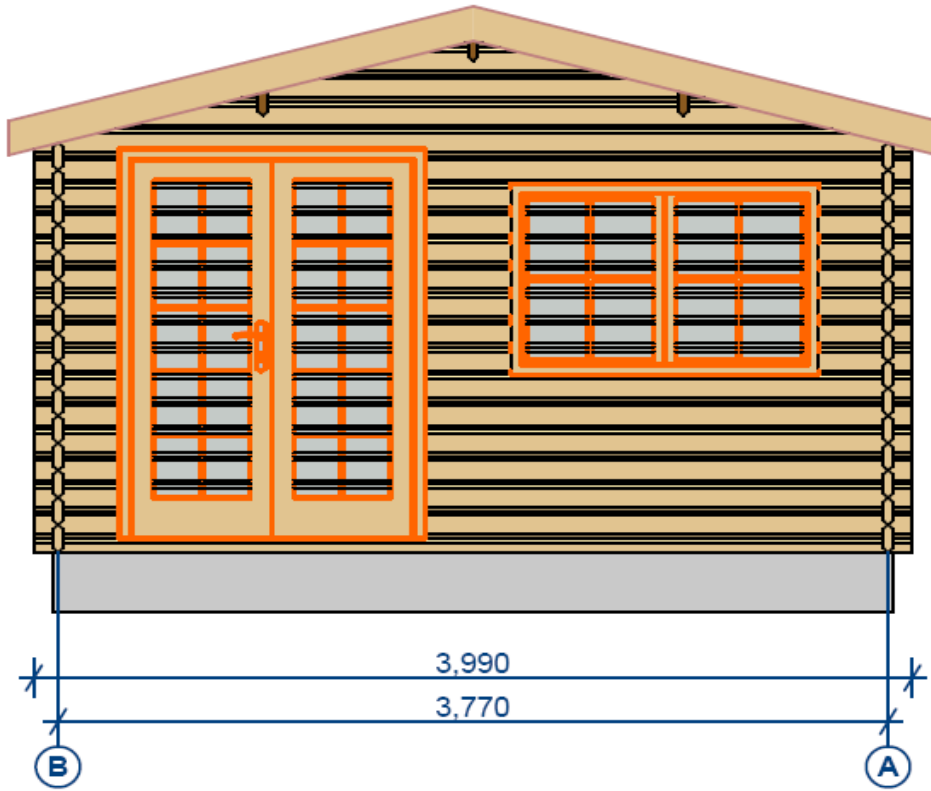

+2.700

+1.995

±0.000

3,990

3,770

B

A

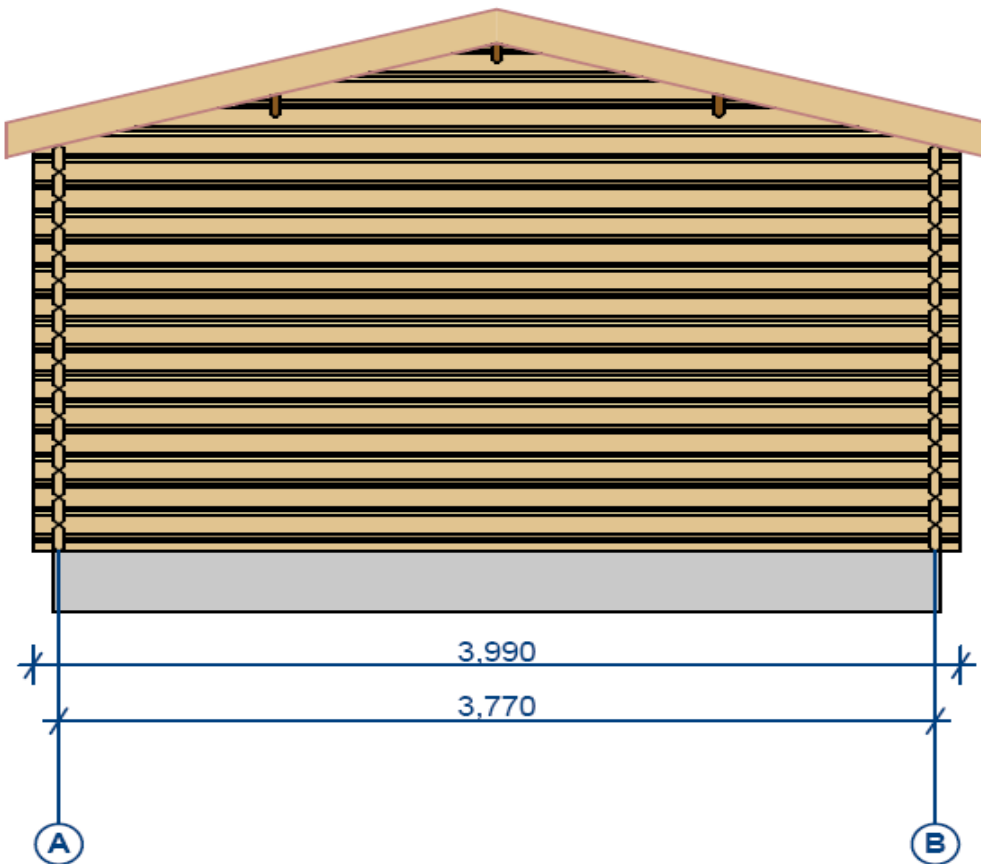

+2.700

+1.995

±0.000

3,990

3,770

A

B

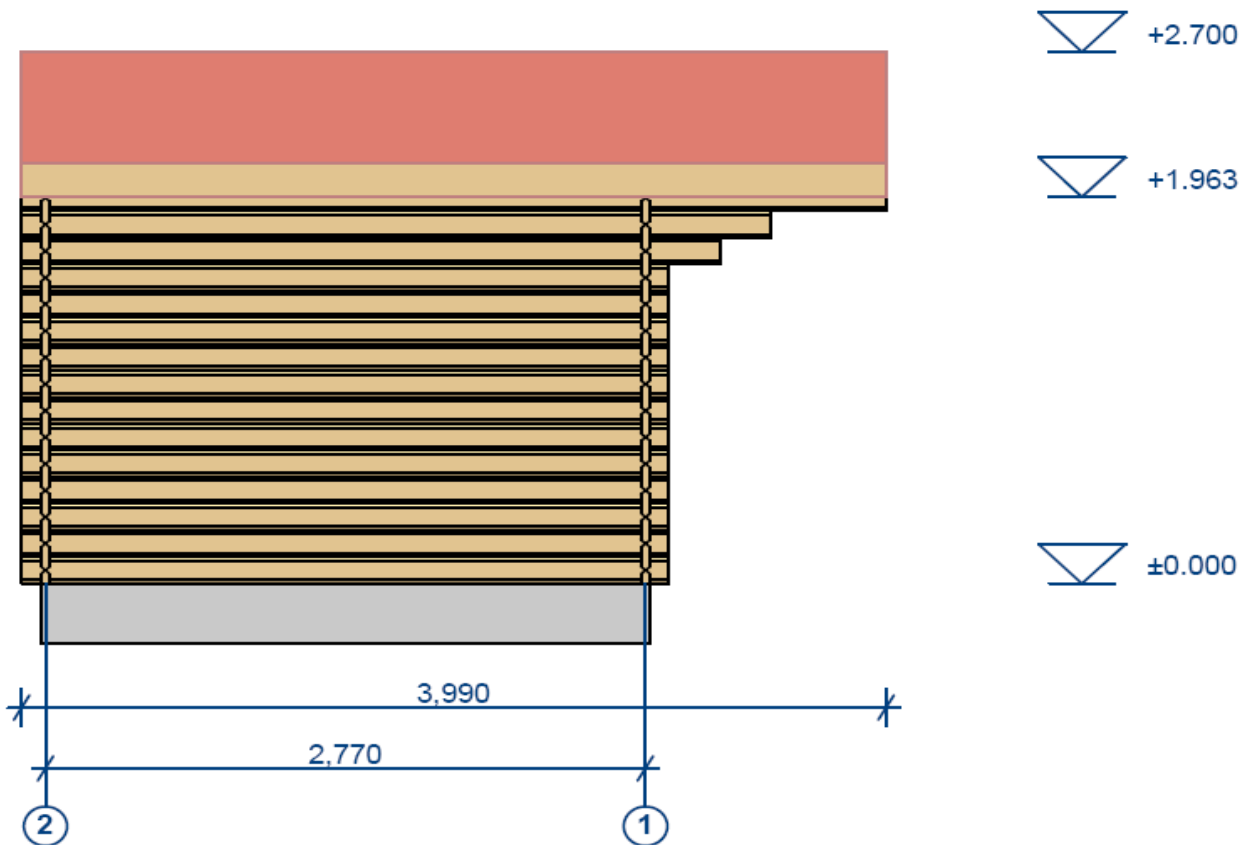
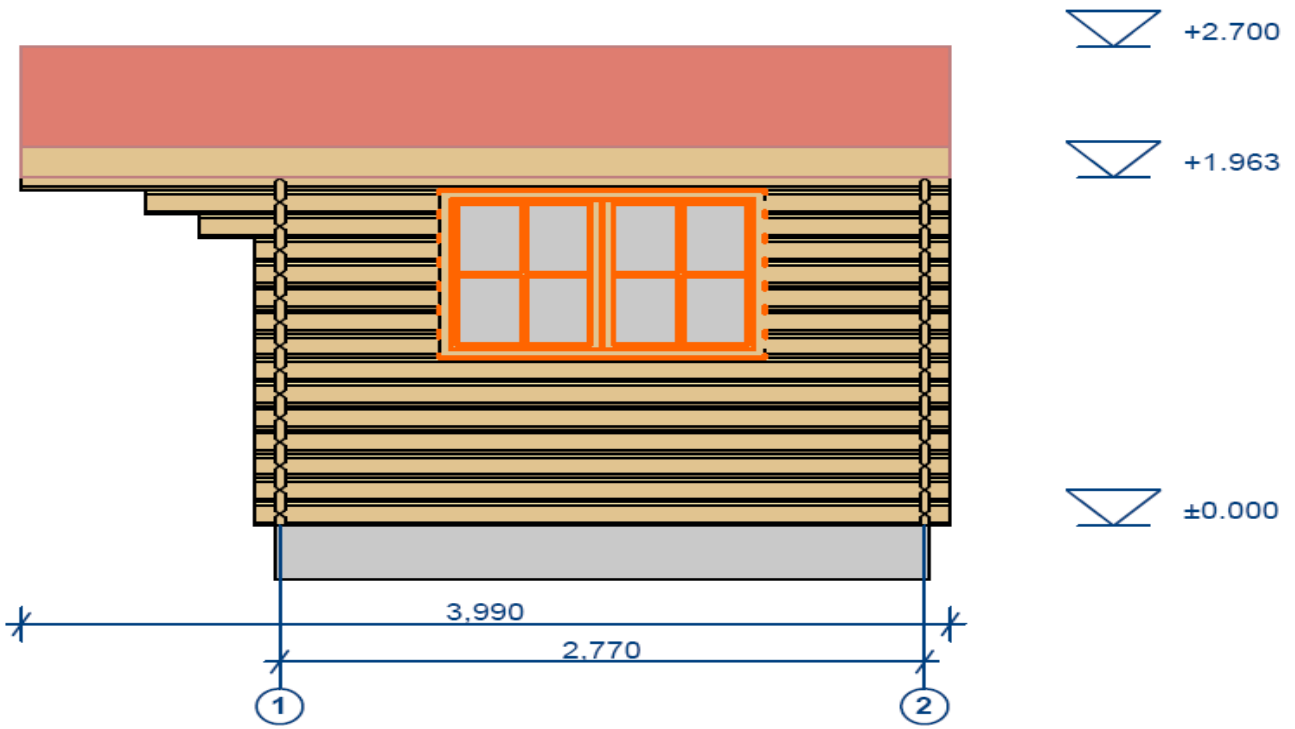

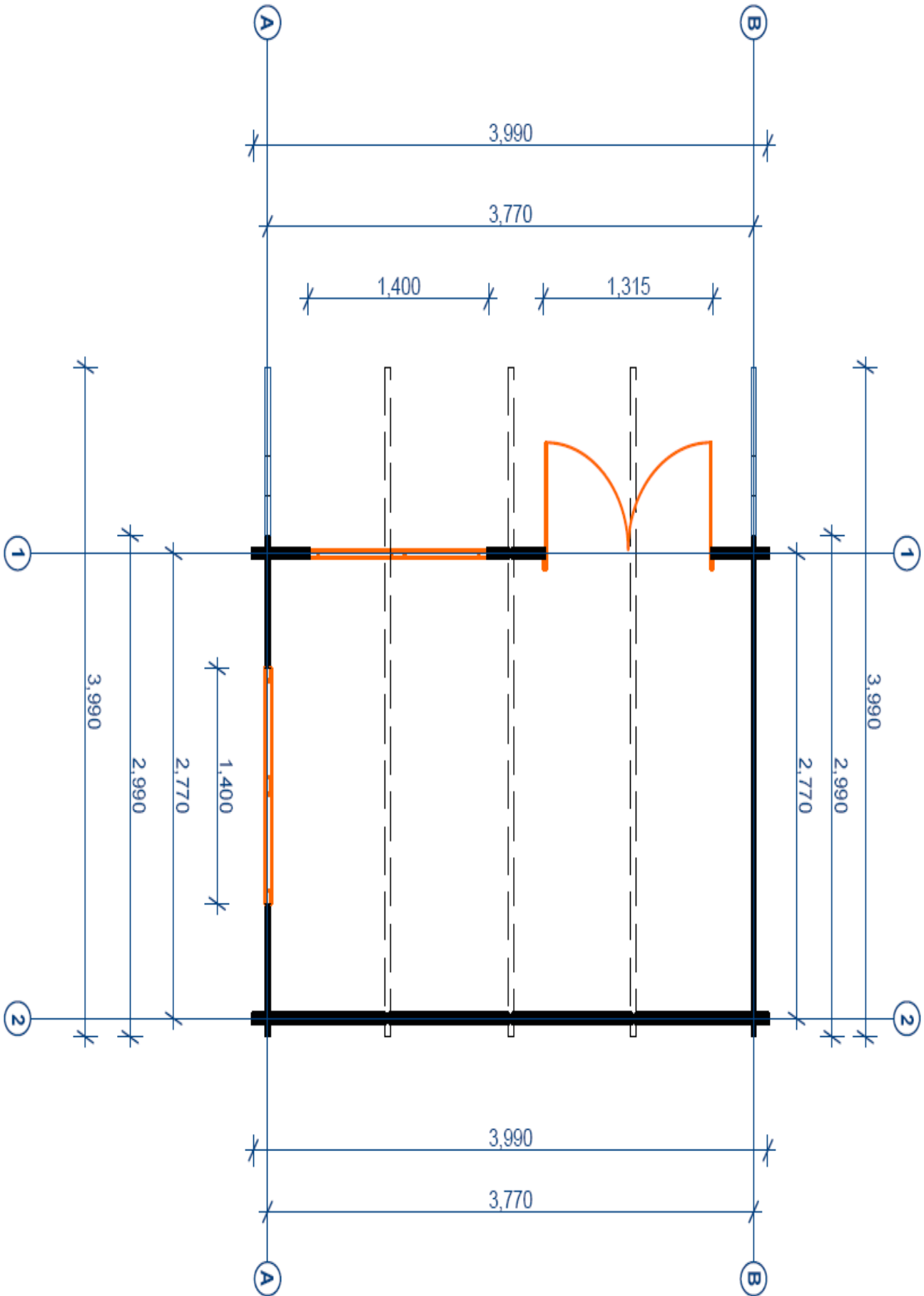



## Doors and windows installation

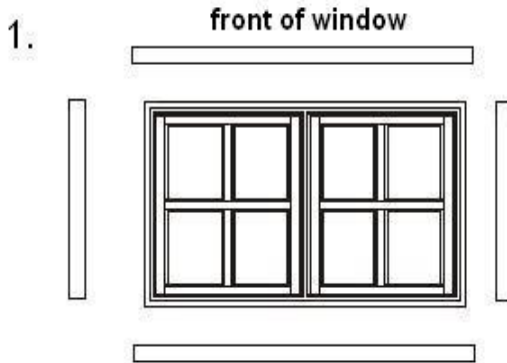

lay window frame on a level surface

lay four pieces of frame around window

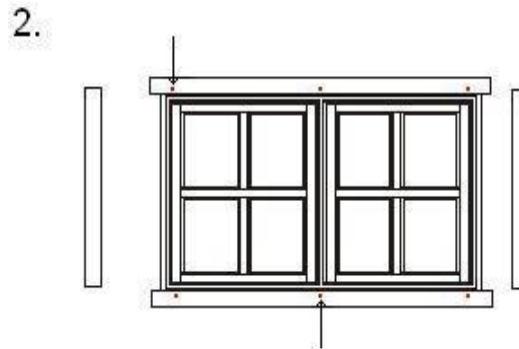

screw top and bottom pieces to window frame as shown

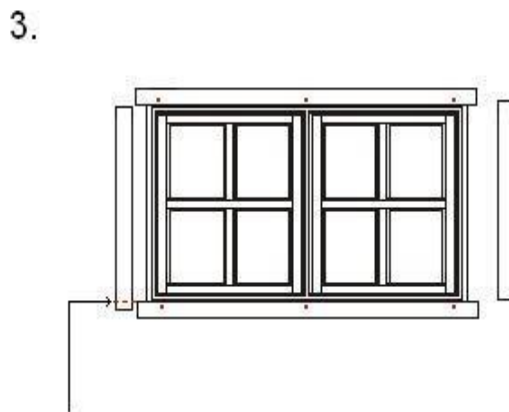

cut side pieces to fit as necessary, then screw to frame as before

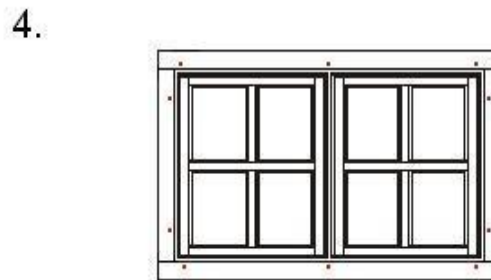

all pieces attached to front of window frame

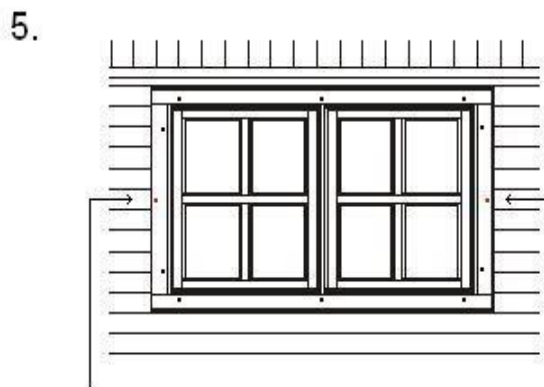

offer up window to cabin and screw in either side to cabin wall to hold in place

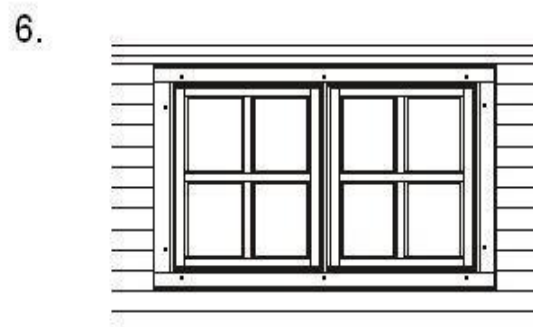

go into cabin and repeat attaching the pieces to the window frames to secure windows

Please note:

Wood is a natural material, which comes with differing textures and colour nuances. These form part of the appeal and natural attraction to this product but also mean aesthetic variations.

Complaints:

If a cause for complaint should arise please follow this procedure:

Inform your retailer and return your control list, describing the problem and making note of any parts nos. that may be damaged. As soon as we receive notification of a complaint we shall do our best to resolve the matter as quickly as possible.

Guarantees are limited to the replacement of incorrect materials.

We trust you enjoy your Log Cabin.

**IMPORTANT - PLEASE READ BEFORE STARTING TILES ASSEMBLY**

Please make sure that the individual tiles are NOT overlapped to cover the darker section. Please refer to the pictures for the correct spacing of tiles. If you assemble the tiles with a larger overlap than recommended you will not have enough tiles to complete your roof. Eurovudas provide the correct quantity of tiles in order to cover your roof according to correct assembly.

The cost of extra tiles and delivery will be paid for by the customer and not Eurovudas ltd.

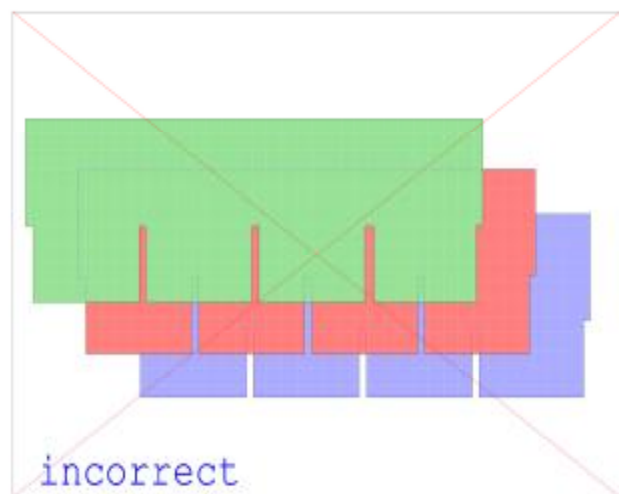
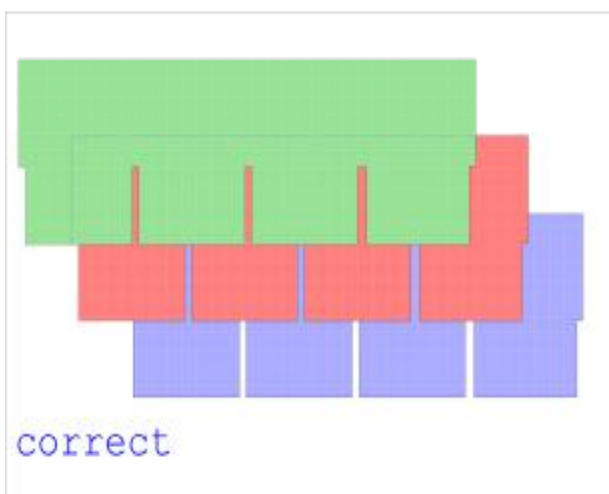
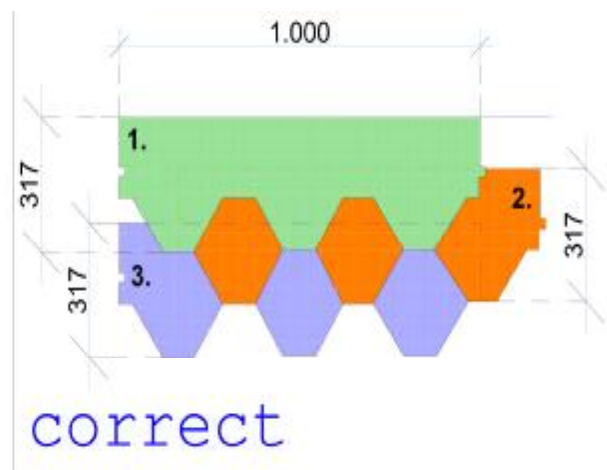
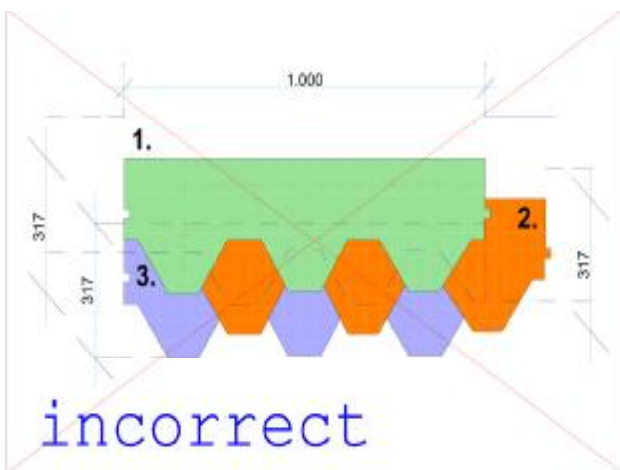

## NOTICE FOR CLIENT

If you have any problems, first of all please contact Your direct seller. In other case per e-mail:

[support@eurowood.lt](mailto:support@eurowood.lt)

or

**for UK customers please call 020 704 397 11**

**other countries +370 5210 12 89**

**Please send us digital photos of the defect parts too, if possible.**

**Customer:** \_\_\_\_\_  
\_\_\_\_\_  
\_\_\_\_\_

**Cabin model:** \_\_\_\_\_

Please provide a description of the needing replacing.

Pos.number from list of detal	Measurment	Quantity	Reason for request

CONTROL LIST

Check date:

NUMBER:

We want to thank you for this wooden garden house purchase. This house was manufactured using the highest technology. The quality was being checked at all times to a high standard. While packing, the number and quality of sections and parts are checked at different stages of manufacture, therefore keeping any problems to an absolute minimum.

However, if it happens, the provider guarantees to replace any faulty parts. If you have any problems please present the documents of your purchase and the Control List to the seller. Please provide a description of the needing replacing.

Checker number :

**For client: Please send us digital photos of the defect parts too, if possible.**

**Cabin model:** \_\_\_\_\_

Pos.number from list of detal	Measurment	Quantity	Reason for request